

Myriad RCT 40 AE - Absorber

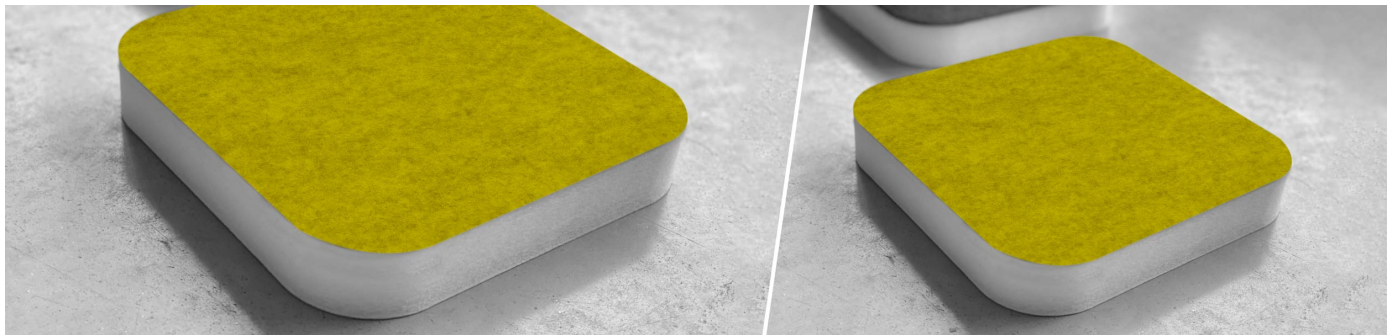

More than a simple acoustic panel, Myriad AE is a design tool that thrives on creativity and imagination. Myriad AE has a lean, elegant shape and comes with a fabric-covered front, and is easily glued to surfaces, and is supplied with an installation template to simplify installing panels with perfect spacing. Built for high-frequency reverberation control, Myriad AE is made of a recycled PET core that rates as a Class 1 material according to the OEKO-TEX® Standard 100. It is available in 3 different fabric finishes, providing multiple colour options and combinations to take the acoustic design possibilities even further.

Features

Type:
Absorber

Absorption Range:
315 Hz to 8000 Hz

Acoustic Class:
B | $(\alpha_w) = 0,80$

Purpose

- Noise Control
- High-frequency absorption
- RT reduction
- Improving speech intelligibility

Recommended for

- Office
- Meeting room
- Conference room
- Open workspace
- Coffee shop
- Restaurant

Performance

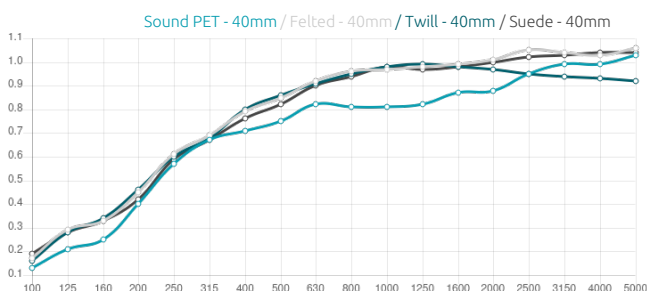

Recycled PET absorption - Class 1 product according to the OEKO-TEX® Standard 100.

This product is available in the following Fire Rates:
FG | Furniture Grade
FR | Fire Rated

PRODUCT COMPOSITION:

Myriad AE | Suede Fabric Finishes (FG)
- Suede Acoustic Fabric
- Sound PET acoustic core - Euro Class B

Myriad AE | Felted Fabric Finishes (FR)
- Felted Acoustic Fabric
- Sound PET acoustic core - Euro Class B

Available Option: The PET used in this product is in the standard white finish. A black PET option is available upon request.

Dimensions:
Myriad RCT 40 - Absorber | 555x1150x40mm

The PET core is a material made entirely from recycled PET plastic, that undergoes an environmentally-friendly transformation process into the non-woven acoustic core we use in this panel. To keep this process as efficient as possible, the thickness of the product may vary slightly (± 3 mm).

Dimensions

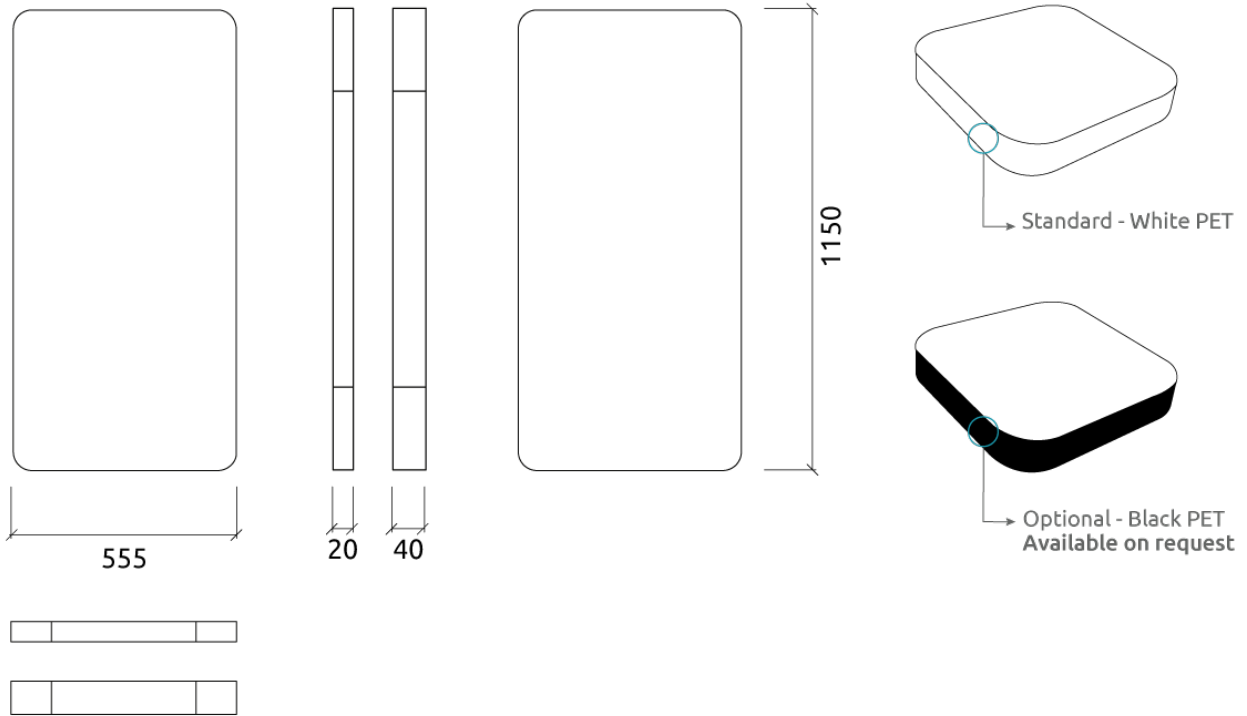

Add-ons



GlueArt



Instant Fix Kit

Dimensions

FR - P | 555x1150x40mm

FR - TT | 555x1150x40mm

FG - SF | 555x1150x40mm

Weight

1.22 Kg

1.62 Kg

1.42 Kg

Box

Quantity per box: 1

Dimensions: xmm

Volume: 0.0m3

Weight: Kg

Myriad RCT 40 AE - Absorber

(FG - SF) Suede Fabric Finishes



FG | (T0272) Snow White

Retail code:
151022010332721



FG | (T0273) Light Ivory

Retail code:
151022010332731



FG | (T0274) Vanilla Beige

Retail code:
151022010332741



FG | (T0275) Earth Brown

Retail code:
151022010332751



FG | (T0276) Grey Beige

Retail code:
151022010332761



FG | (T0277) Mink Grey

Retail code:
151022010332771

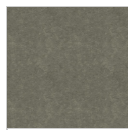

FG | (T0278) Ash Grey

Retail code:
151022010332781

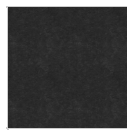

FG | (T0279) Anthracite Grey

Retail code:
151022010332791

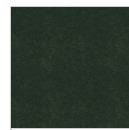

FG | (T0280) Bottle Green

Retail code:
151022010332801

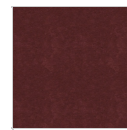

FG | (T0281) Wine Red

Retail code:
151022010332811



FG | (T0282) Violet Blue

Retail code:
151022010332821



FG | (T0283) Ink Black

Retail code:
151022010332831

(FR - TT) Felted Fabric Finishes

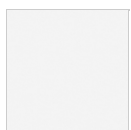

FR | (TT211) Pearl

Retail code:
152022010332111



FR | (TT212) Granola

Retail code:
152022010332121



FR | (TT213) Rust

Retail code:
152022010332131



FR | (TT214) Clay

Retail code:
152022010332141



FR | (TT215) Cherry

Retail code:
152022010332151



FR | (TT216) Lime

Retail code:
152022010332161

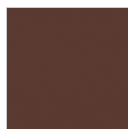

FR | (TT217) Chocolate

Retail code:
152022010332171



FR | (TT218) Storm

Retail code:
152022010332181



FR | (TT219) Indigo Blue

Retail code:
152022010332191



FR | (TT220) Ash

Retail code:
152022010332201

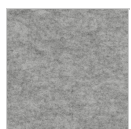

FR | (TT223) Pewter

Retail code:
152022010332231



FR | (TT224) Espresso

Retail code:
152022010332241



FR | (TT225) Lemon

Retail code:
152022010332251



FR | (TT226) Honey

Retail code:
152022010332261



FR | (TT227) Spice

Retail code:
152022010332271



FR | (TT228) Orchid

Retail code:
152022010332281



FR | (TT229) Ruby

Retail code:
152022010332291



FR | (TT230) Kelly

Retail code:
152022010332301

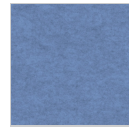

FR | (TT231) Cerulean

Retail code:
152022010332311

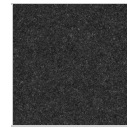

FR | (TT232) Crow

Retail code:
152022010332321

(FR - P) Raw PET Finish



FR | (F06) White Raw PET

Retail code:
024322010330021



FR | (F07) Black Raw PET

Retail code:
024322010330051